

## **Rubber Designs Interlocking Tile Installation Procedures**

<b>Introduction.....</b>	<b>3</b>
<b>Product Storage</b>	
1. Adhesive.....	4
2. Rubber Designs Interlocking Tiles.....	4
3. Geo-Textile.....	4
<b>Tools &amp; Consumables</b>	
Recommended Tools & Consumables.....	4
Personal Protective Equipment.....	5
Optional Equipment.....	5
<b>Site Survey</b>	
1. Sub-Surface Drainage	
a) Naturally Draining Sub-Surface.....	5
b) Non Draining Sub-Surface.....	5
c) Solid Sub-Surface.....	5
d) Slope.....	5
2. Orientation	
a) Direct Sunlight.....	5-6
b) Continual Shade or Damp Areas.....	6
<b>Site Preparation.....</b>	<b>6</b>
<b>Site Preparation - Pre Sub-Surface</b>	
1. Remove all Sod and Topsoil.....	6-7
2. Install Water Collection System.....	7
<b>Site Preparation - Sub-Surface</b>	
1. Test Sub-Surface for Proper Slope.....	7
2. Test Sub-Surface for Proper Grade.....	8
3. Repair all Variations in Grade.....	8
4. Auguring of Sites Will Disturb Existing Base Surfacing.....	8
5. Curb Heights to be the Height of the Tile Surface or Higher.....	8
6. Inspect Concrete Finish-No Cracks, Loose Material.....	8
7. Prepare Your Surfaces for Proper Adhesion	
a) Make sure Concrete and Asphalt Surfaces are Dry.....	9
b) Confirm that the Concrete or Asphalt has fully Aged/Cured.....	9
c) Mechanically Prepare the Area as Required.....	9
d) Acid Etch to Enhance Cleaning .....	9
e) Power Wash Sub-Surfaces That Are Dirty or Oily.....	9

## **Prior to the Installation of Tile**

1. Measure the Site and Record Dimensions.....9
2. Check to Ensure Non-Encroachments Zones, Fall Heights and Fall Zone Clearances.....9
3. Confirm Adequate Materials to Complete Installation.....9
4. Atmospheric Temperature above 40°F (5°C) & Rising.....9
5. Coefficient of Thermal Expansion.....10
6. Watch for Variance in Color Tones.....10
7. Installation of Geo-Textile .....11

## **Confirm Site Size and Layout**

1. Multi-Colored Surface.....11
2. Test Proper Measurements Prior to Commencing with Installation.....11-12
3. Checking for Square.....13

## **Adhering Tiles**

- Before Adhering Tile – Checklist.....14
- Adhesive Facts.....14
- Key Points.....14
- Preparing the Equipment.....15
- Adhesive Methods.....15
- Adhesive Clean-Up.....16

## **Installing Tiles**

- Installing the Surface - Key Point Method.....16
- Install First Row in L-Shaped Pattern.....17

## **Marking and Cutting Tiles**

- Marking and Cutting Perimeter Tile.....18-19
- Marking Posts.....20-21
  - a) Cutting Tile.....22
  - b) Cut Hole Smaller or Tile Larger.....22
  - c) Installing Cut Tiles.....22

## **Application Methods**

- Perimeter to Retaining Wall.....23
  - a) Outdoor Installation to Curb.....23
  - b) Outdoor Installation with Concrete or Asphalt Substrate - Adhere to Base.....23
  - c) Outdoor Installation of Edge Support U-Lock).....23
- Perimeter with Rubber Designs Interlocking Ramp.....23
- Perimeter to Topsoil/Sod.....24
- Playground Post Cuts.....24

Adhesive Application Techniques.....	24
Key Points.....	24
<b>Summary.....</b>	<b>24</b>
<b>Final Installation Details</b>	
1. Remove Any Adhesive Spills	
a) “Smearred” Adhesive Spill.....	25
b) “Bead-Shaped” Adhesive Spill.....	25
2. Initial Appearance and Maintenance.....	25
3. Initial Odor.....	25
4. Sealant.....	25
<b>Routine Maintenance</b>	
1. Routine Maintenance Extends Life and Enhances Appearance.....	26
2. Blowing / Sweeping.....	26
3. Vacuum.....	26
4. Water Hose.....	26
5. Cleaning Agents.....	26
<b>Advance Maintenance</b>	
1. Steam Vacuum.....	26
2. Power Washing.....	26
<b>Checklists.....</b>	<b>27</b>
<b>Questions.....</b>	<b>28</b>
<b>Installation Inspection Form.....</b>	<b>29</b>
<b>Installation Inspection Form.....</b>	<b>30</b>

**Introduction**

It is our goal to excite your expectations for quality, performance, value and service. As the manufacture of Rubber Designs Interlocking tile we will recommendation that you read this Installation Manual prior to beginning installation of your Rubber Designs Product Interlocking safety surfacing system. By reviewing this manual you will save valuable time on the project while avoiding some of the most common installation errors.

**Should you have any questions or concerns please contact us at Rubber Designs @ 888-653-7529**  
**The final quality of any playground surface is highly dependent on the techniques used by the installation crew.**

## **Product Storage**

1. Adhesive Storage- Container can rupture if exposed to high heat. Do not store near open flame, heat or other source of ignition. Keep container sealed in order to avoid contamination. Store indoors in a cool, well ventilated area. Storage Temperature-60°F minimum to 100°F maximum. Adhesive shelf life 6 months to maximize product performance.

### 2. Rubber Designs Interlocking Tile

To ensure that the product is dry and above 40°F at installation time, the tiles should be stored in a location with temperatures above 40°F for at least 52 hours prior to the installation date. Tiles that will be stored for a long period of time prior to installation should be stored indoors and out of direct sunlight. See further notes for storage during installation.

### 3. Geo-Textile (if required)

Store all manufacturer supplied Geo-Textile in a dry storage area.

## **Tools & Consumables**

Like any job, your Rubber Designs Interlocking Tile installation will go much smoother with the proper tools. The following list of tools and consumables are recommended for your upcoming project:

- Broom
- Leaf blower
- Aluminum straight edge 30 inch minimum
- 24 inch framing square
- Measuring tape
- Felt tip marker/paint tip marker to mark tiles for cutting (Sharpie™ – metallic silver or equal)
- Chalk line & refill bottle
- String line
- Heavy-duty auto lock cutter utility knife and replacement blades
- Jig saw (minimum 5.5 amp or greater recommended)
- Jig saw blades (down-cutting blade; 10 teeth per inch)-Should be 1/4 inch shorter than the thickness of tile
- Templates – for marking post holes for cutting. (PVC pipe cut 2" thick in various sizes works well.)
- Duct or masking tape to protect adjacent items during adhesive application
- Disposable rags and/or paper towels (adhesive clean-up)
- Methyl Ethyl Ketone (MEK), also known as Methyl Acetone or Xylene for cleaning purposes
- Caulking Gun
- Thermometers – for measuring ambient and surface temperature
- U-Notched trowel with 1/4" or 3/8" deep grooves - standard ceramic tile adhesive spreading trowel, for perimeter tile to base adhesive spreading at installation edge

### **Personal Protective Equipment**

- Disposable protective gloves (latex, nitrile or other) – for adhesive application
- Gloves (general work gloves)
- Safety glasses
- Hard hat
- Knee pads

### **Optional Equipment**

- Vacuum cleaner
- Bent extension
- Hole saw – for scoring posts
- Weed sprayer – for moisture misting – low humidity days
- Band saw for volume cutting (scalloped blade)
- Flex curve Site Survey

### **Site Survey**

#### **1. Sub-Surface Drainage**

It is important for the sub-surfaces to drain properly for both interior and exterior Rubber Designs Interlocking Tile installations.

##### **Naturally Draining Sub-Surface**

If the installation site is elevated with natural drainage, and does not currently collect water, then additional storm water management may not be necessary.

##### **b) Non Draining Sub-Surface**

If the installation area is lower than the adjacent grades and tends to collect water, or if water puddles on the sub-surface, then a sub-surface water management system must be installed.

##### **c) Solid Sub-Surfaces**

If the sub-surface is solid (i.e. concrete or asphalt) and water collects on the surface deeper than 1/4" (0.25") in any area where the tiles are to be adhered to the base, these areas must be filled with patch materials recommended by the concrete or asphalt supplier. (See surface preparation section).

##### **d) Slope**

It is important that the sub surface be sloped a minimum of 1% toward the water collection drains.

#### **2. Orientation**

Note: The final orientation of the installed surface may not be a matter of choice, some consideration should be given to the following items.

##### **a) Direct Sunlight**

Rubber Designs Interlocking Tile is made from recycled rubber. Rubber absorbs heat from exposure to direct sunlight, rather than from exposure to atmospheric temperature. If the surface area is exposed to continual direct sunlight, design considerations should include lighter colors that reflect infrared light. (Lighter colored surface will provide a modest impact on surface temperatures).

**Sun exposure is one of the potential safety threats on playgrounds. Any child, youth or adult can suffer from harmful UV rays penetrating their skin, or they can be burned by play equipment or rubber surfacing that has become too hot from sitting in direct sunlight. Avoid these risks by, implementing trees and other shading devices can be planned into the design of a playground area for sun protection or avoid play during times when UV rays are the strongest.**

#### **b) Continual Shade or Damp Areas**

Installation sites with continual shade may remain damp for long periods of time. During warmer temperatures damp areas may be subject to mold growth. Tile surfaces in shaded areas have the potential for mold growth and should be cleaned on a regular bases.

#### **Site Preparation**

Rubber Designs Interlocking Tile system ideal sub-surface must be a firm and level surface with minimal undulations. For gluing to the surface it is critical that the surface is also clean, dry and free of oils.

- The recommended sub-surface is properly cured and installed concrete.
- Another alternative available is properly aged and prepared asphalt. To ensure proper adhesion, the oils in the surface cannot be present and the asphalt surface strength needs to be ensured.
- A third alternative is a properly leveled and compacted sub base of 3 to 4 inches of (3/4 inch minus) aggregate of the correct size, type and consistency with a minimum properly leveled and compacted 1 inch layer of (1/4 inch minus) "chip & dust" or "granite screenings". Considerable care and skill is required to install a granular surface properly.

**NOTE:** This manual is not intended as an extensive guideline for installation of aggregate sub-surfaces.

Proper preparation of the sub-surface is critical to the long term success of your project. Due to the importance of proper sub-base preparation, Rubber Designs has illustrated a few of the elements specifically addressing the correct sub-surface preparation techniques required to obtain a surface suitable for a tile installation. The overview is in no way an instructional guide for sub-surface installation.

#### **Site Preparation - Pre Sub-Surface**

Note: Base preparation is covered under a separate contract from the Rubber Designs Interlocking Tile installation guide.

The following information is provided as a brief guideline for those installations that do not have a properly prepared base.

##### **1. Remove all Sod and Topsoil**

Remove topsoil until solid, packed and stable sub-soil is visible and level.

## Site Preparation - Pre Sub-Surface

### **2. Install Water Collection System**

Survey the site for drainage. Inspect the area after a rainstorm or test with local water supply. If this test results indicates the necessity to install a drainage collection system, then complete the following steps:

- a) Excavate trenches to contain perforated PVC pipe. Top of PVC pipe should be level with bottom of intended granular base. (PVC pipe is preferred over corrugated plastic drain tile because of the tendency for plastic drain tile to become crushed during its life cycle).
- b) Install perforated PVC pipe with correct slope. Connect ends.
- c) Wrap perforated pipe with landscaping fabric.
- d) Back fill trenches with 3/4" clean stone. This 3/4" stone should wrap the drainage pipe to a diameter of approximately 12".
- e) Tie drainage system into existing storm sewer or ditch. Restore finished surfaces over trenched areas with appropriate ground cover (sod, etc.).

**Note:** A properly designed and installed water collection system is often overlooked during tile site planning stages. The tiles are permeable, and water will pass through the Rubber Designs Interlocking system, so it is critical that a proper sub-surface drainage system be installed. Failure to do so could result in damage to the sub-surface and or Rubber Designs Interlocking Tile surface.

## Site Preparation - Sub-Surface

For Packed Aggregate Sub-Surfaces see the Guideline Provided by Rubber Designs, Inc. Entitled: Sub-surface Preparation Guide.

1. Test sub-surface for proper slope – should be minimum of 1%.

During heavy rains, water will collect on surfaces with slopes that are less than 1% or if the grade of the surface is not consistent. The surface

should be able to accommodate 25 year storm water volume. If water collects on any non-porous subsurface (asphalt or concrete), the adhesives can be affected over time. If significant water volumes cannot escape from the sub-surface and water backs up under the tiles, the hydraulic pressure could also result in a damaged installation. To test the grade and drainage, flood the area with water and mark puddles with chalk. Puddles deeper than 1/4" and larger than 1" diameter should be patched.



2. **Test sub-surface for proper grade.** Frequently, sub-surface preparation is completed under separate contract to the Rubber Designs Interlocking Tile installation. When the subsurface is completed under another contract it may not be smooth enough for an immediate Rubber Designs Interlocking Tile installation because:

- a) Aggregate sub-surfaces often become disturbed in the time between sub-surface installation and Rubber Designs Interlocking Tile installation.
- b) The sub-surface contractor may not have taken the care and necessary steps to achieve a smooth and compacted surface.

**Note: Any undulations in the sub-surface will be visually apparent in the finished Rubber Designs Interlocking Tile surface.**



**3. Repair or have repaired by the sub base installer all variations in grade that are greater than +/- 1/4" over 10' (in any direction)**

**a)** Patch solid sub-surfaces with materials recommended by the concrete or asphalt manufacturer.

**b)** The site should have properly leveled and compacted minimum 1 inch layer of (1/4 inch minus) "chip & dust" or "granite screenings". This would be on top of a properly leveled and compacted sub base of 3 to 4 inches of (3/4 inch minus) aggregate of the correct size, type and consistency. If surface required more leveling and smoothing additional aggregate may be required or additional "chip & dust" added and compacted.

**4. Auguring of sites will disturb the existing base surfacing.** Where concrete/asphalt or granular surfaces have been removed or disturbed ensure that the areas are well compacted and sloped away from the posts. These areas should not be lower than the surrounding areas.

**5. Curb heights are typically specified to be the height of the tile surface or higher.** An unlevelled subsurface or curb is not cosmetically pleasing. Cutting the base of the tile to match the curb height is not recommended.

**6. Inspect concrete finish to ensure there are no cracks and/or loose material.** Concrete should have a light broom finish for best surface adhesion. A heavy broom finish will result in a higher than normal adhesive usage. Ensure that there are no significant cracks and that the area is level.

**Note: A properly prepared, cured and dry concrete or asphalt sub-surface is the ideal sub-surface for Rubber Designs Interlocking Tile.**

**7. Preparing your surfaces for proper adhesion.**

**a)** Concrete - It is important that the surface be completely dry to avoid adhesive failure. Since the perimeter tiles must be adhered to the concrete or asphalt sub-surface, it is important to ensure that it has cured sufficiently. Normally this is a minimum of 28 days for concrete. Allowing the concrete to sufficiently cure will ensure that most of the moisture has left the sub-surface. Less than 3lbs moisture per 1,000 square feet is the ideal dryness level before applying adhesive. If the surface has a layer of "cement paste" it should be removed to ensure proper adhesion.

**b)** Asphalt may require longer curing time to allow the oils to dissipate. Some asphalt surfaces may have a significant amount of tars or oils and the adhesive should be tested to ensure adhesion. After the adhesive has cured and if the tiles



can be pulled up with asphalt or concrete attached to the glue, it is the base that has failed and not the adhesive. There are different qualities of concrete and asphalt.

c) Mechanically prepare the area as required. For concrete, that does not have a broom finish around the area to be glued should be mechanically prepared (sandblasted or hand grinder) then cleaned to remove any dirt or dust. The same is for asphalt but a bond test should be done every time.

d) Acid etches to enhance cleaning (optional).

**Note: Etching the concrete increases the adhesion by opening the surface pores of the concrete. Etching may be required on older surfaces with fuel, oil or other contamination.**

Mix 25% Muriatic acid by volume to water (1 part Muriatic Acid to 3 parts water). Wash the entire area with this solution. A light broom scrub will be sufficient. After the complete area has been etched, carefully rinse the entire surface and allow adequate time for the concrete to completely dry.

e) Power wash sub-surfaces that are dirty or oily. Power washing is recommended on older concrete to properly clean the area. This is especially important if the concrete or asphalt has been contaminated with fuel, chemicals, dirt etc.

### **Prior to the Installation of Tile**

\*SEE ADDENDUM FOR CHECK LIST

#### **1. Measure the Site and Record Dimensions**

**2. Check to ensure non-encroachment zones (usually 6 ft beyond fall zone), fall heights (usually based on deck height or overhead equipment) and the fall zone clearances (meet local minimum requirements (usually minimum 6 ft or further for slide exits and for swings double the height). This is important in ensuring correct tile thicknesses are used to meet the local standards. If information is not on work order check with equipment manufacture/installer and or customer.**

#### **3. Confirm Adequate Materials to Complete the Installation**

It is important to have enough products to complete the entire installation in a single installation session for the following reasons:

**Note: During the quoting and material calculation process variance in tile dimension will have been taken into consideration when calculating tile quantities.**

a) Rubber Designs Interlocking Tile Plus and Rubber Designs Interlocking Tile Premium, like new wood, concrete, asphalt or painted surfaces will change color with exposure to UV. This change is not as noticeable when all of the installed tiles change color at the same time. However, like installing a new piece of wood beside an old one, there will be a noticeable difference in the color tone of tiles installed at separate times.

b) Installing all tiles in one session ensures similarity in installation conditions and efficiency.

**4. Atmospheric Temperature Above 40°F and Rising Atmospheric temperatures should be above 40°F for at least 24 hours and preferably climbing.** Viscosity, work life and final cure time of the adhesive will vary dramatically with temperature. Tile installation is not recommended if/when temperatures are expected to remain below 45°F for an extended period of time.

## 5. Coefficient of Thermal Expansion

Rubber Designs Interlocking Tile is manufactured from a combination of recycled rubber material and polyurethane binding resins. The high composition of rubber based materials make the product susceptible to heat related expansion and contraction. On hot sunny days the following guidelines should be carefully followed to minimize the impact of heat related expansion and contraction on the final installation.

- Keep the tiles stacked, covered and out of direct sunlight prior to installation. Remove tiles from the pallet only as they are needed. By keeping the tiles stacked, the insulating properties of the tile can be utilized by keeping the lower rows of tiles cool.
- Plan to begin your installation as early as possible while temperatures are cooler.
- Plan to apply adhesive during the earlier part of the day before the tile expand too much and end at least 3 hours before the sun begins to set.
- When the temperatures become such that it increase the tile size is preventing proper alignment of the seams, Spend the balance of the day making tile cuts for your perimeter and equipment posts.
- Many installers often install tile at night to minimize heat related expansion.

**Note:** For night installation allow 48 hours for glue to cure properly.

## 6. Watch for Variance in Color Tones

Rubber Designs Interlocking Tile Plus may have a slight variance in color tone from tile to tile. This is due to the recycled nature of the raw materials used in the production of rubber safety tiles. Visual effects of color variation can be minimized by placing these tiles in a less visible area such as under play decks. Rubber Designs Interlocking Tile Premium may also have a temporary color change due to the effects of UV on the thin layer of binder on the top of the EPDM or wear course. This thin layer will be influenced by UV which will appear to yellow or discolor the top surface. This thin layer will then begin to dissipate exposing the original color of the EPDM granules. These changes range in time, but we have found that in a period of 6 weeks to 3 months, you should have your original color back in which it will stay constant with proper maintenance for the life of the product. You do not notice this color alteration in the darker colored EPDM's, but you will in the lighter and brighter colors, such as blue, grey and beige.

## 7. Installation of Geo-Textile

Should the sub-base be compacted granular the surface will require a covering of geo-textile. A geo-textile is a permeable polymeric textile, either non-woven, knitted or woven material used in direct contact with the ground. This is required to protect the migration of granular particles into the bottom or settling of tile into the granular sub base. A suitable product would be (200g per yd<sup>2</sup>) or equivalent. Overlap the joints least 12". Continuously seal joints with polyurethane adhesive material used for tile to tile and tile to base adhesive).



tile  
by at  
(same

## Confirm Site Size and Layout

When preparing for your initial site layout there are some important factors to take into consideration.

First, the Rubber Designs Interlocking Tile pieces are manufactured to a dimension of 25" x 25" inches with lock and with a manufacturing tolerance of plus or minus 3/16th inch.

Second, it is unlikely that your site is perfectly square or exactly as shown in the drawings.

When the site is curbed or recessed the rule of thumb is to plan on beginning and ending with a cut piece of tile. By planning to begin and end with a cut of at least 10 inches you will be assured of a visually proportionate site.

### 1. Multi-Colored Surface

**Note: A shop drawing of the installation should accompany multiple colored Rubber Designs Interlocking Tile installations with surface patterns. Confirm the shop drawing is accurate to actual site measurements and customers expectations prior to commencing installation.**

2. Take Proper Measurements Prior to Commencing with Installation since Rubber Designs Interlocking Tile dimensions can vary by +/- 3/16 inch it is very important to connect a row of tiles and take the exact measurement of the entire row prior to beginning installation. The theoretical length of 15 tiles should be 30 feet however the actual length may be slightly shorter.

\*In Figures 1 through 4 we have used a site dimension of 30' by 30'. We used a sample dimension of 29'11" for the row of connected tiles.

**Note: To ensure a visually proportionate site, lay the surface out with equal dimension cuts on all four sides of the site. In most instances, when ramp edging is not used, plan on beginning and ending with cut tiles of roughly equal dimensions. For visual purposes cut tiles should be a minimum of 10 inches.**

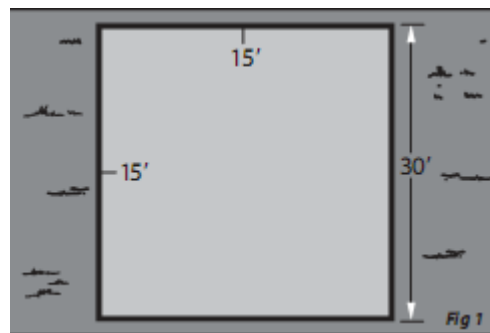

a) Measure and mark the center point on both the length and width of the site (Fig 1 - Overhead View).

b) Given Rubber Designs Interlocking Tile manufacturing tolerance of plus or minus 3/16", begin by obtaining an accurate measurement of a row of tiles. Lock together a row of tiles equal to the length and width of the site and measure the dimension (Fig 2). We have used a site dimension of 30X30.

Using this example the theoretical length of a row of 15 tiles should be 30 feet however the actual length could be shorter.

c) Using both the measurement from the halfway point to the perimeter and the measurement of the row of tiles you will be able to determine the size of the perimeter cuts. In our example the halfway point is 15' and the measurement of the row of tiles at the halfway point measures 14' 11 1/2 inches. Installing the full row of 15 without calculating the cuts would leave us with a 1/2" gap on each of our site (Fig 2a). To avoid this we will be centering 14 tiles which leave us with a 1' 1/2" gap on each side of the site (Fig 2b). By increasing the perimeter cuts from 1/2" to 1' 1/2" we create a more visually attractive installation (Fig 2c).

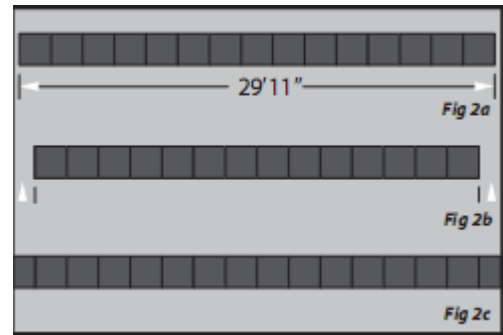

to  
tiles  
side  
will

Once the size of the outside perimeter cuts have been determined we are ready to string our lines which will be the basis for the beginning of the installation.

d) String a line parallel to the retainer. The distance between the retainer and the first string line should be equal to the size of the perimeter cuts. Based on our example this measurement is 1' 1/2".

e) String a second line along the adjacent retainer forming an "L" shaped string line (Fig 3).

**Note: For ease of installation install the field of tiles first leaving the outside perimeter cuts until last.**

Now that the approximate size of the outside perimeter cuts has been determined, we are ready to string our lines which will be the basis for the beginning of the installation.

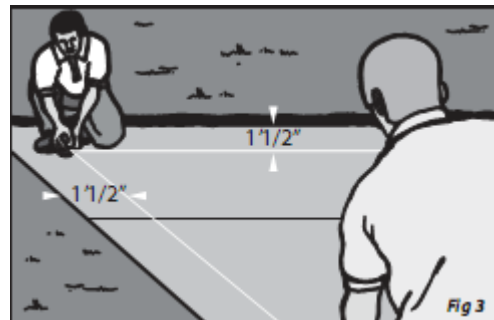

**Note: Prior to beginning installation it is important to ensure that the string line is square. Ensuring that the string line is square will provide a smooth and neat installation. In order to check for square we will be using what is often referred to as the "three-four-five" (or "six-eight-ten") method.**

### Checking Square

**NOTE:** For best results the string line should be strung just slightly higher than the thickness of the tile. This ensures the string is always visible and the tile can be aligned to the string or used as a measuring point. A chalk line only works as a point of reference until you cover it with the tiles.

**a)** Measure 3 feet (or 6 feet) down one side of the string line and make a mark (Fig 4a - Overhead View - Line a-b).

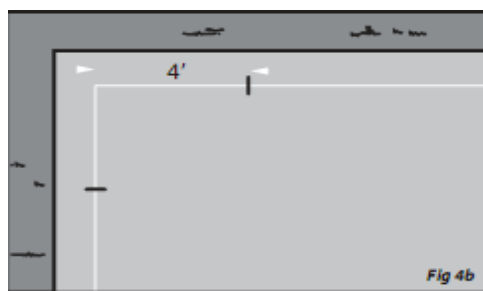

**b)** Measure 4 feet (or 8 feet) down the perpendicular string line and make a mark (Fig 4b - Line a-c).

**c)** Measure the distance between the two marks at b and c. If the corner angle is square (90 degrees) the measurement between b and c is 5 feet (or 10 feet) (Fig 4c).

**D)** If the measurement of the line between b and c is more or less than 5 feet (or 10 feet), your lines are not in square and you will need to move one or both of the lines in or out until you reach the 5 foot (or 10 foot) measurement (Fig 4b). The decision on which way to move your lines will depend on the visual effect it will have on the perimeter cuts. The general rule of thumb is to designate the least visual side of your playground for the majority of any uneven cuts.

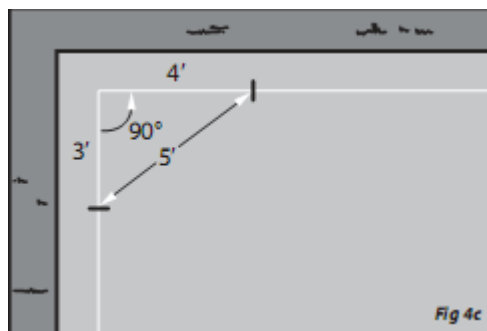

**Note:** These instructions assume the adjacent walls and support structures are square. In the event non-square walls result in very thin cut-strips at the edge of the layout, move entire layout in a direction that allows cut pieces to be a minimum (cosmetically and structurally) acceptable size. The minimum acceptable size is 6" inches.

Installing tiles on a site that is grossly out of square is beyond the scope of this installation guide. If you discover that your site is grossly out of square STOP and confirm site layout. Consult the customer or contractor

## Adhering Tiles

The unique locking design of the tile was probably one of the factors involved in your decision to purchase a Rubber Designs Interlocking Tile safety surface. In order to maximize this unique feature it is important to understand that our locking system was engineered to be most effective when used with the proper quantity and placement of adhesive.

**Note: Prior to beginning the adhesive application, the following checklist should be verified.**

### Check List

- Verify layout and design. Check your layout and the drawings to ensure that your installation will represent the intended design.
- Make sure that your test rows are straight and that all of the seams are properly aligned and tight.
- Correct any undulations in the surface.
- Sub surface is dry and clean. When gluing to the base verify that the sub surface is clean and dry. Dirt and moisture is the single greatest cause of bonding failure.

### Adhesive Facts

- Optimum temperature for substrate and sealant is between 60°F and 95°F with 50% relative humidity
- Adhesive cures by reaction with atmospheric moisture. At low temperatures and humidity the curing reaction process is slower. Therefore cure rates are dependent on temperature and humidity.
- Adhesive is workable up to 60 minutes.
- A 30 oz Glue tube of adhesive bonds approximately 36-40 lineal feet of tile edging.
- A 1/4 inch bead cures in approximately 16-24 hours at 75°F and 50% relative humidity
- Adhesive requires 5 days curing at 75°F prior to submersion under water.

### Key Points

- Only use adhesive provided by or recommended by the manufacturer.
- Adhesive comes ready to use. Do not open glue tubes until preparatory work has been completed.
- Proper application of adhesive to the tile lock joint is critical to the overall performance of your new safety surface.
- **Using too little adhesive, or applying the adhesive in the incorrect location can result in failure of the locking system and could result in voiding the warranty.**
- **Sealing the entire length of the seam will prevent damage caused by the migration of sand and other loose particles into the seams of the product.**
- Surfaces must be clean and completely free of moisture.
- Surface temperatures above 40°F degrees and rising are recommended.
- Avoid adhesive applications below 40°F and above 105°F.
- Protective gloves should be worn to prevent skin contact.
- Tiles are glued to the sub-surface with tile to base adhesive.

### **Preparing the Equipment**

In order to minimize any potential mess during adhesive application, a small set up area should be created using a piece of cardboard or other disposable covering material. Prior to beginning the adhesive application, make sure you have rubber gloves; plenty of rags, utility knife and Methyl Acetone (MEK), Acetone or other suitable solvents for clean up purposes.

Whether a manual dispensing gun or a battery operated unit is used, the adhesive application procedure is very similar.

1. Open the dispensing unit by pulling back plunger to allow room for the glue tube.
2. Inserting the adhesive tube in chalk gun.
3. Hold the dispensing unit upright to allow the tube to slide entirely into the unit.
4. Ensure the glue tube fits in the gun properly.
5. Using your knife, cut the adhesive tube at a 45 degree angle to allow for a minimum of a 1/4 inch of adhesive to apply to tile locking mechanism.
6. Avoid adhesive spills and clean up by properly discarding the empty tubes and cut ends of adhesive.
7. If you are unsure of the initial dispensing flow you may consider doing some trial runs to get a feel for the appropriate speed you must travel, as well as how much pressure to apply in achieving 96 lineal feet per tube.

### **Application Methods**

Adhesive application methods vary slightly depending on the type of installation and the substrate that the system will be placed on. Regardless of the substrate used, all Rubber Designs Interlocking s systems have minimum adhesive application requirements.

**Specific application instructions for tile-to-tile adhesion will be addressed later in this section.**

**Tile to tile adhesive is properly placed in the interior wall along base of the u-shaped locking system. Placing the correct amount of adhesive onto the proper location of the product will ensure the long term success of the installation (Fig 3a).**

It is advantageous to start with the gluing of the perimeter tile to the base first. This will ensure that the tile surface will remain tight.

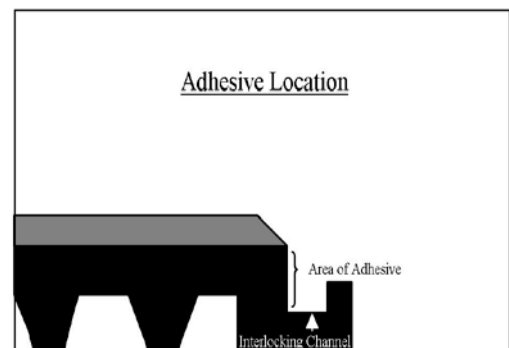

### **Perimeter to Retaining Wall**

For edge and base adhesion which is recommended for outdoor applications.

#### **a) Outdoor Installation to Curb**

In order to ensure adhesive contact between the tiles and curb, it is imperative that an adhesive is applied between the edge of the tile and the retaining wall or curb.

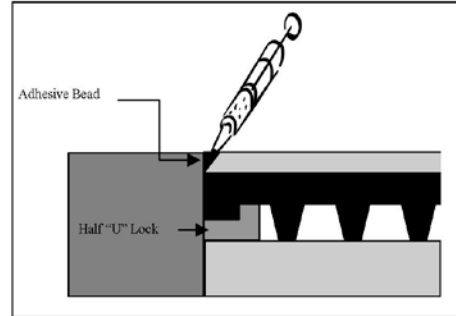

#### **b) Outdoor Installation with Concrete or Asphalt Substrate**

##### **Adhere to Base**

Tile adhesion is done by turning the tile over, and applying a 1/4" diameter bead of adhesive along the grid pattern of the tiles or by applying the adhesive to the tile using a rough nap paint roller.

##### **Roll on method**

Using a rough nap paint roller and paint tray, coat roller in adhesive removing any excess glue from roller to reduce splattering. Roll on the glue for only one row of tile at a time. For the L shaped pattern you may go left to right and up and down. Install each row of tile as you go. The glue should be applied to the tile and not the sub-base.

##### **Perimeter with Rubber Designs ramp**

Rubber Designs ramps are all manufactured with a female lock.

##### **Ramp interlocking options:**

- Placement of the tile to utilize the tile locking mechanism.
- U-lock is for locking two female parts.

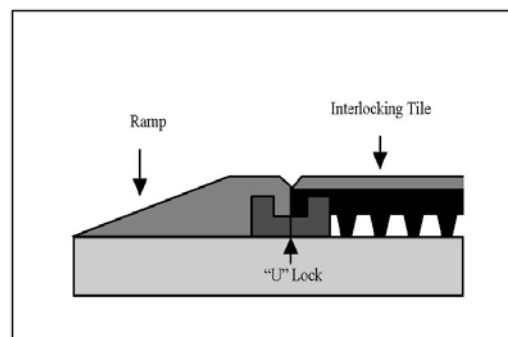

**Note: The tile installer must determine the placement of the first row of tile so that the locking mechanism on the tile is utilized.**



## **Application Methods**

**Note: Installation of ramps should be completed during the cooler part of the day.**

When a transitional edge piece is used, on the female sides of floor you will need to use a U-lock. Place a U-Lock under both the tile and ramp or transition piece apply glue on both sides of the U-lock to ensure bond.

## **Perimeter to Topsoil/Sod**

When the site edging will be an open tile and the surrounding back filled with top soil and sod- cut the exposed male locking sections and glue it into the female locking sections, creating a stable edge and minimizing the likelihood of the migration of topsoil, grass and other debris under the tile surface.

## **Playground Post Cuts**

Adhesive should be applied in the cut from tile edge to post hole.

## **Application Tip**

The adhesive application tip must be cut to allow a minimum of a 1/4" bead of glue when applying glue to the locking parts of the Interlocking tile. To minimize seepage pay careful attention to ensure that the correct amount of adhesive is being applied. Too little adhesive will affect the performance of the locking system. Too much adhesive will result in overflow requiring removal of the excess adhesive the following day.

## **Adhesive Application Techniques**

Storage of adhesives prior to use in a climate controlled environment will ensures proper and consistent flow rates and ease of application, especially during cooler temperatures. It is recommended that the adhesive be stored in a minimum temperature 60 degrees.

The ideal quantity of adhesive will provide sufficient contact to both locking parts of the tile.

Each tube contains approximately 32 to 36 lineal feet of material.

Because the adhesive is a moisture cure sealant, the sealant can be lightly misted with water when installed in arid climates or when you wish to accelerate the cure rate. A garden sprayer can be used for this purpose.

Any excess adhesive should be left to fully cure (approx 24 hrs) prior to removal the following day. The excess adhesive can be quickly and neatly removed using a sharp razor knife.

## **Summary**

- Proper application and quantity of adhesive to the Rubber Designs lock is critical to the overall performance of the surfacing system.
- Only use adhesive provided by or recommended by the manufacturer.
- Protective gloves should be worn to prevent skin contact.
- Take caution to ensure that adhesive is not spilled on adjacent surfaces.
- Uncured adhesive spills can be removed with a rag and Methyl Acetone (MEK), Acetone or other suitable solvents.
- Cured adhesive can only be removed by mechanical means.
- To clean your tools use a small folded piece of paper or "Q-tip" and solvent such as, Methyl Acetone (MEK),

**Acetone or other suitable solvents.**

Mistakes/Repairs will need to be replaced the day off installation to allow best workability of uncured glue. If glue is already cured you will need a small thin pry bar to create small opening between tiles to cut adhesive with sharp razor knife being very careful not to damage surrounding tiles.

**Installing Tiles**

**Installing the Surface**

Rubber Designs Inc. Installation techniques have been designed so that the adhesion process takes place during the tile installation, to ensure that the tiles are locked in place and properly aligned and tightly fitted and glued to the adjoining tile on all sides.

**KEY POINT METHOD**

Our unique interlocking system was designed for ease of installation, however, the process can be challenging if the correct techniques are not used. To maximize speed and efficiency install Rubber Designs Interlocking Tiles in the following manner.

- Place the alignment foot on the bottom of the Rubber Designs inside the predetermined 90 degree corner.
- Apply 1/4" bead of glue along the wall in the base of male U shaped locking sides before placing next tile in position.
- Place alignment foot in top left corner in space provided on each tile locking the female lock on top of the male lock and press in to position.
- Once all four locks have been secured, align the seams with all of the adjacent seams.
- Adjust the tiles so that it is tight and snug.

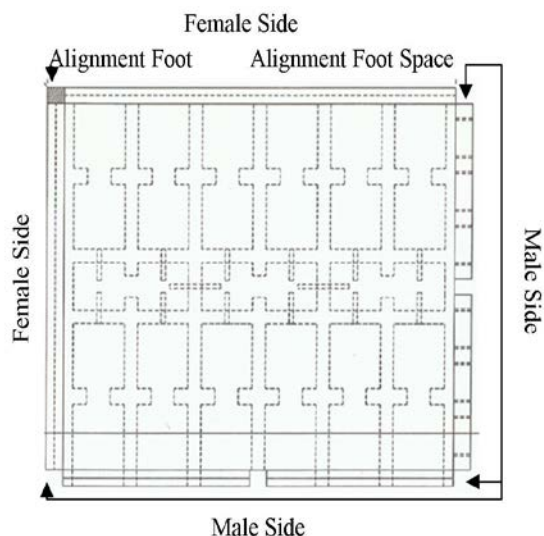

For sites smaller than 3000 square feet the chalk or string lines can be placed in the position as detailed above. However if the site is larger the location for lines when possible should be as close to the center of your site as possible (it is easier to maintain straight lines if posts aren't in the way of your initial tile layout). For larger sites the installations should be installed in quadrants, always working out from the original chalk or string line.

- a) Using the KEY POINT METHOD above, install the first row of tiles (approx. 8 to 10 tile) along the string line gluing only the connecting male lock. The edge of the tile should align with the string line.

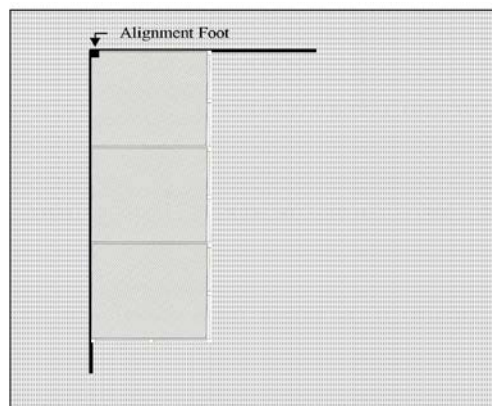

The tiles are designed to fit as tightly as possible to the adjacent tile. Some force may be required to achieve the tight fit. This is normally done by using a rubber mallet or the heel of your foot to align the tiles and insure tight fit.

### Install First Row in L-Shape Pattern

- b) Install the second row of tiles along the second string line forming an “L” shaped installation gluing only the connecting male lock. (Fig 5b).

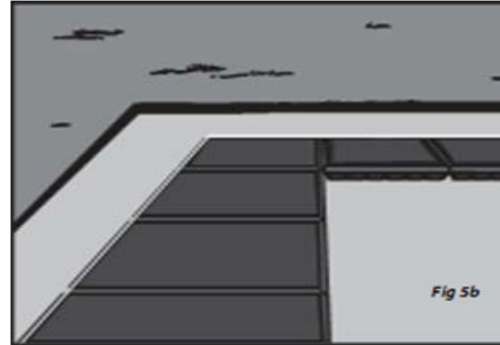

Continue to install tiles inside the L-shape. Be sure to use the aligning technique on each row installed, forcing each row against itself as well as against the adjacent row of tiles (Fig 5 c).

**Note: Glue can be applied to the entire row of male locks to speed installation.**



**Note: Attention must be given to the amount of force used to align the tiles. Too much force will put the installation out of alignment.**

Continue filling in the field of the project using the KEY POINT METHOD and following the “L” shaped configuration.



**Note: For ease of installation, leave all cuts until last. Do not glue adjacent tiles.**

## **Marking and Cutting Tiles**

**Note:** It is imperative that tile are in their correct position, fit together tight and lines are straight before tile measuring and cutting begins.

Start to measure, mark and cut from the tile which lies in the direction of your string line whenever possible and work your way out from those starting points (key line). Be sure to install each tile as it is cut, this will ensure a proper fit for the next cut tile. When these cut tile are installed, the seams need to match neighboring seams. It is critical that as you move through your cut tiles that the seams match the adjacent tile.

**GOAL – make edge cut to post or site curbs as tight as possible, to ensure a cosmetically pleasing finish.**

**When marking and cutting edge or perimeter tile, be sure to cut the tile larger by 1/8 to a 1/4 inch.**

**When marking and then cutting around the post, be sure to cut the hole 1/8 inch smaller than the pole circumference.**

### **Perimeter Marking**

Mark any cuts for the perimeter tile pieces in the following manner:

1. With a 24 inch square minus the 1" lock, begin on the edge of the perimeter void where the tile needs to be placed and take a measurement from the edge of the perimeter to the edge of the last placed full tile. Transfer this measurement onto the tile that has been selected to be cut (Fig 6a - Overhead View).



2. Move the 24 inch square or the tape measure approximately 3 inches across the void where the tile will be placed and take a second measurement. Move the same distance across your tile to be cut and transfer the second measurement onto the tile (Fig 6b).



**Note:** Continue this process until enough reference points have been transferred onto the tile. Straight regular cuts may only require two measurements per tile however irregular perimeters such as circles will require measurements in 2 or 3 inch increments across the tile. You can slide the square along the curve and get a reading of 'a and b' of pin point any location along the curve (Fig 6c).

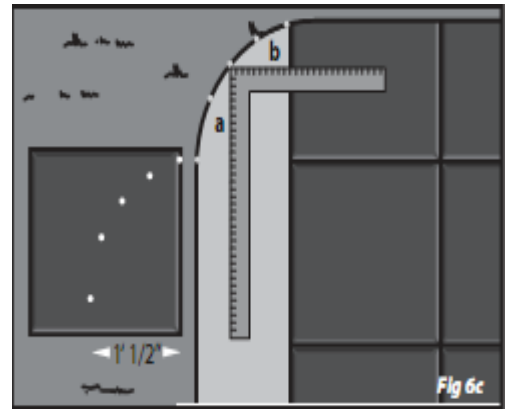

**3.** After the measurements have been transferred onto the tile to be cut, connect the markings using a flexible aluminum straight edge and felt tip marker. (Fig 6d).

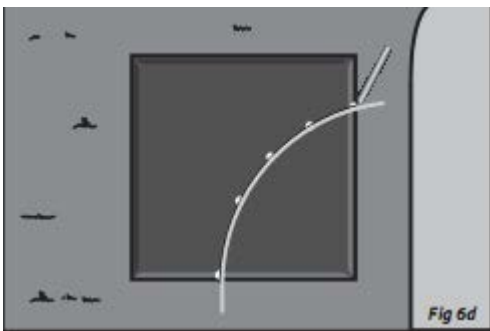

**4.** Continue measuring and marking all perimeter tile pieces.

**Note:** In the event that a full tile is placed against a retainer, it may be necessary to remove the “male” lock to allow the tile to fit flush. The lock unit can be used as support on the female lock side as needed. (Fig 6e)

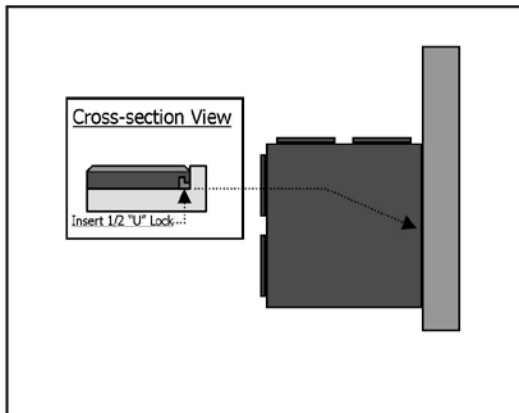

Overhead View

## Marking Posts

**Note:** The diameter of playground equipment posts vary across the industry. If you are unsure of the diameter of your equipment post you can calculate it by measuring the circumference of the post and multiplying by .31831.

It is imperative that tile are in their correct position and fit together tight and lines are straight before tile measuring and cutting begins. Measure from the “key line”.

1. Determine the diameter of your posts and use a purchased template or make a template out of a hard material such as PVC Pipe cut in 2” sections. PVC pipe sizes range from 1 to 8 inches to accommodate most playground equipment post or pedestals. A five inch diameter post would require a 5 inch or smaller circle for a template. A 4-3/4 inch or 4-7/8 inch template would help in obtaining a smaller circle and a tighter finish to the pole.

A 2 foot square and a silver felt tip marker work well to mark tile for cutting, the square allows you to make a small mark in the correct position/location. Do not make large long lines that will be exposed after cutting, try to pinpoint your marks, or at least keep marks as small as possible. **Measure twice to make sure you have measured correctly.** When marking tile or cutting tile always remember to make the cut a 1/8 inch closer to the pole to ensure a tight fit.

2. For easy visual reference place the tile to be cut near to and in a similar orientation to its final placement position (Fig 7a). When posts are located on a seam, place two tile joined together.

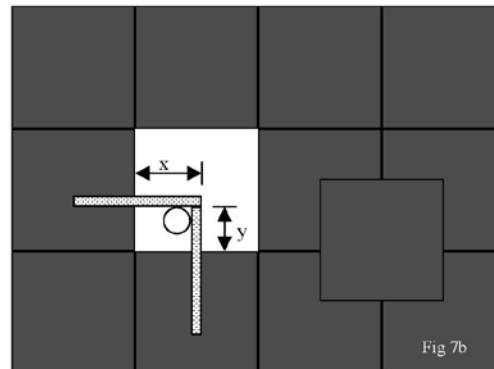
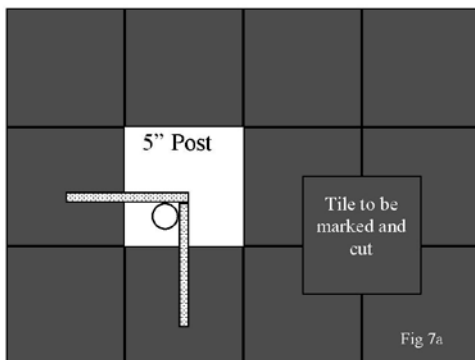

**Note: Position the pole inside the framing square**

3. Using the square you will be taking two measurements. Measure the exact distance from **x** to key lines of adjacent tiles to outside corner of the square. Follow the same procedure for **y**. (Fig 7b)

## Marking Posts

4. Center the square at the location where your two measurements the key line sides of tile. The marking should be in the form of a line small as possible, but still visible. (Fig 7c)

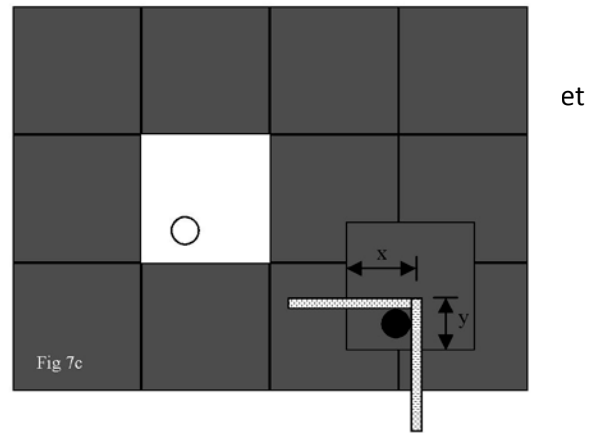

5. Place your template into the center of the “square” and mark the perimeter of the template. You are now ready to make your cut (Fig 7c).

Note: If you use PVC pipe you will also be able to mark inside of pipe for a closer cut around pole.

Note: You will need to cut into the side of the tile before you make your circular post cut. When doing so you will typically cut the side of the tile that represents the shortest distance from the tile edge to the cut (Fig 7d) Sometimes, however, you may wish to hide this joint or place this joint out of a heavy traffic area. The line should be made in a position that is between the pedestals.

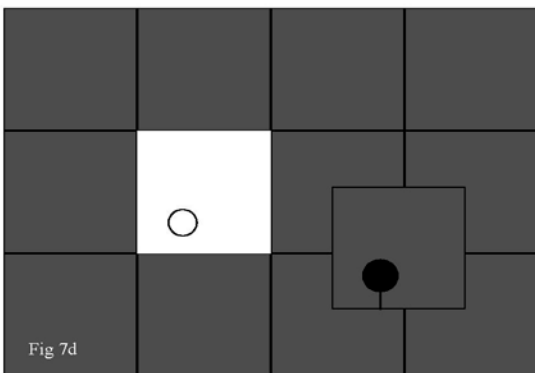

## **Cutting Tiles**

The utility knife is used for straight cuts and the jigsaw is used for straight and irregular cuts. Never start your cut with the jigsaw blade that has teeth, always use your utility knife to make the initial cut from edge of tile to edge of post cut. Use a straight edge or square for straight cuts with the knife. When using a jigsaw for cutting use a 15 to 20 degree back angle on the tile.

Place tile on a flat, level and hard surface. It can remain exactly where you have been measuring as long as precautions are taken so the tile beneath are not damaged. When using a jigsaw, ensure that the blade is a 1/4 - 1/2 inch shorter than the thickness of the tile when the jigsaw is in the extended position. When cutting with the utility knife score the area to be cut first. Once a score has been made, apply pressure to the tile to open the score. Placing the tile over a short 2X4 will help open up the scored section for cutting with the knife. Opening the score of the tile reduces friction between the tile and the knife making the cut much easier. Continue making the cut through the tile.

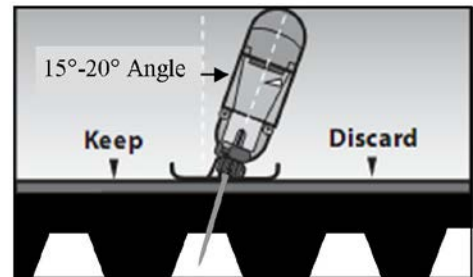

### **a) Cut Hole Smaller or Tile Larger**

Since rubber is flexible and has the ability to compress it is always better to make your post hole cut a fraction smaller than required. This will allow for a very tight fit.

Making the posts cut on a back angle 15 to 20 degree's allows for a tight neat appearance and provides some additional flexibility.

A simple reminder, that it's easier to do 2 cuts than trying to "stretch" a short piece!

### **b) Installing Cut Tiles**

Always install the cut tile to ensure a proper fit prior to trimming the bottom of the tile for surface mount plates and nuts if needed. We recommend installing all post cuts before going back and trimming the bottom of the tile.

**REMEMBER - If in doubt, measure twice, cut once!**



## **Final Installation Details**

### **1. Remove any Adhesive Spills**

- a) "Smearred" Adhesive Spill – Try not to smear further. If a small amount of adhesive is spilled onto the surface during installation, this can be removed immediately by wiping the spot with a rag containing a small amount of Methyl Acetone (MEK), Acetone or other suitable solvents. Use proper handling procedures. Try to "lift" the adhesive if possible from the surface.
  
- b) "Bead-Shaped" Adhesive Spill - If any adhesive inadvertently drips out of the end of the caulking tube onto the Rubber Designs Interlocking surface, and this adhesive lies on the tile in a convex shaped bead, with extreme caution it can be lifted immediately (do not smear) with a cloth or knife. If unable to lift it should be removed only after it has partially cured. Area will need to be protected so the area is not walked on. After curing you will need to use a knife to "scrape" the bead off of the tile.

### **2. Initial Appearance and Maintenance**

Solid Rubber Designs Interlocking Tile colors will behave like new carpets when initially installed. The solid, brilliant colors will make the initial dust created by foot traffic very apparent. However, with time, the visible dust tracking will diminish.

### **3. Initial Odor**

The polyurethane used to bind the rubber tile is 100% inert and odorless after it has fully cured. Full curing can take up to several days depending on atmospheric temperature and moisture. The odor may take longer to dissipate for indoor applications because of the confined area. The rubber may also have a slight odor.

### **4. Sealant**

It is Rubber Design's recommendation to only apply sealants that is manufactured specify for the GTimpax tile to any Rubber Designs interlocking surface.

Should you have any questions about sealing or coating the surface of the Rubber Designs Interlocking product, please contact our office.

**Should you have any questions or concerns please contact us at Rubber Designs @ 888-653-7529**

**The final quality of any playground surface is highly dependent on the techniques used by the installation crew.**

## **Routine Maintenance**

**1. Routine Maintenance Extends Life and Enhances Appearance.** Like any surface, a good routine maintenance program will enhance the longevity and appearance of the Rubber Designs Interlocking s surface. Failure to comply with a maintenance program could result in invalidating the warranty.

### **2. Blowing/Sweeping**

Blowing with a leaf blower is the best way to remove any loose debris from tile surface and seams of connecting tile. Not all play areas will accommodate a leaf blower. Sweeping the surface will be the most common method of keeping the Rubber Designs Interlocking surface clean. However, because of the porosity and granular texture of the surface, it is difficult to remove all contaminants by sweeping alone.

### **3. Vacuum**

Periodic vacuuming is recommended in areas where sand is frequently tracked onto the surface.

### **4. Water Hose**

Use a water hose with a pressure spray tip to remove contaminants from porous top surface. This is easier than using a broom. However, interior installations may place restrictions on water usage.

### **5. Cleaning Agents**

Rubber Designs Interlocking s<sup>®</sup> can accommodate moderate use of most household or bio-degradable detergent that contain both odor suppressants and disinfectants. Dilute this cleaning agent as recommended by the manufacturer. Apply to the surface using a mop or scrubbing device. This will remove most light stains.

## **Advanced Maintenance**

Depending on frequency of use, Rubber Designs Interlocking will occasionally need a “deep clean” to remove built up dirt and stains.

### **1. Steam Vacuum**

A steam vacuum with or without cleaning agents is ideal for advanced cleaning and maintenance. Follow instructions.

### **2. Power Washing**

In areas that can accommodate power washing, use a power washer with a wand tip.

### **3. Extend life roll on varnish**

Extend life is a roll on application that will rejuvenate the color of the standard SBR top tile.

This application is only cosmetic and will have no adverse on the CFH.

Manufacturer will recommend adding Extend Life after three years depending on playground uses.



The entire Rubber Designs Products team wishes to thank you for your careful consideration and decision to purchase a Rubber Designs Interlocking safety surfacing system. Your investment in a Rubber Designs Interlocking system is a wise one. The locking feature found in our design will not only make your installation simpler but it will enhance the appearance, strength and durability of your safety surface for years to come.

It is important to note that proper installation is a critical component to the overall success of your surface and this manual has been prepared with the long-term performance of your surface in mind. By carefully following the procedures set forth in this manual, you can be assured of a quality installation.

It is our goal to exceed your expectation for quality, performance, value and service. As industry leaders we are committed to the long-term success of your project.

***We are available by phone at 888-653-7529 from 8:00 am to 5:00 pm, Monday through Friday, EST.***

# CHECKLISTS

## INSTALLATION CREW/PEOPLE ON SITE

- Company Name(s) – Employee Name(s) – Position(s)
- Personal Protective Equipment (PPE)
- Tool List

## PRE-INSTALLATION SITE INSPECTION CHECKLIST

- Surface Condition
- Surface Cleanliness
- Surface Planarity
- Surface Compaction
- Site Dimensions
- Materials Received
- Atmospheric Temperature
- Surface Temperature
- Fall Heights and Zones

## POST-INSTALLATION SITE INSPECTION CHECKLIST

- Cleanliness
- Joints Tight
- Cuts Accurate Tight
- All Seams Adhered
- All Edges or Cuts Adhered

Use Installer Inspection Sheet

## GENERAL COMMENTS & PHOTOS

---

---

---

---

---

---

---

---

---

---

---

## QUESTIONS

## **PRODUCT STORAGE**

1. What materials will you need to properly store?
2. How are the materials recommended to be stored?

## **TOOLS & CONSUMMABLES**

1. List the safety gear that may be required on the site
2. List the recommended tools required for site preparation.

## **SITE PREPARATION**

1. What types of surfaces are ideal as a sub base for a Rubber Designs Interlocking Tile installation?
2. What is the recommended surface slope for any site?
3. What should be done to prepare the differing types of surfaces?  
for a Rubber Designs Interlocking Tile install?

## **PRIOR TO TILE INSTALLATION**

1. List at least 5 items that should be remembered or checked for  
in preparation of an installation
2. How does temperature affect the installation?

## **CONFIRM SITE SIZE**

1. What is the tile tolerance of a Rubber Designs Interlocking Tile?
2. What are the steps taken to layout the site after you have taken  
the site dimensions?
3. How do you check square?

## **INSTALLING TILES**

1. At what two locations may you begin laying out the tile?
2. What tile do you lay first?
3. What tile do you lay last?
4. What is critical when laying tile?

## **MARKING & CUTTING TILE**

1. What tools are required for marking the tile?
2. What tools are required for cutting the tile?
3. What is critical when cutting tile?

## **ADHERING TILE**

1. What tools are required to adhere tile?
2. What is critical before adhering tile?

## **PERIMETER FINISHES**

1. What are some of the differing perimeter finishes that have  
been used?
2. How do you do to finish these different types of perimeters?

## **FINAL INSTALLATION DETAILS**

1. Before leaving the site what should you do?

## INSTALLATION INSPECTION FORM

Facility or Site Name: \_\_\_\_\_ Inspection Date/Time: \_\_\_\_\_

Address: \_\_\_\_\_

Installation Date(s) & Weather Conditions: \_\_\_\_\_

Installation Company: \_\_\_\_\_ Crew Leader: \_\_\_\_\_

- Include list of all installation team members on site
- Include photos of before and after shots
- Record temperatures and weather each day while on site

1. SUB SURFACE CONDITIONS	Yes	No	COMMENTS
Concrete Curbs .....	<input type="checkbox"/>	<input type="checkbox"/>	_____
Concrete Keyway Under Ramp and Tile .....	<input type="checkbox"/>	<input type="checkbox"/>	_____
Width of Key way _____			_____
Concrete (preferred surface) Cured .....	<input type="checkbox"/>	<input type="checkbox"/>	_____
Old <input type="checkbox"/> New <input type="checkbox"/>			_____
Asphalt .....			_____
Old <input type="checkbox"/> New <input type="checkbox"/> 12 Inch Concrete Key ways <input type="checkbox"/>			_____
Ground Off Surface to Granular <input type="checkbox"/>			_____
<b>2. SITE CONDITIONS - General</b>			
Cleanliness of Site .....	<input type="checkbox"/>	<input type="checkbox"/>	_____
Damage .....	<input type="checkbox"/>	<input type="checkbox"/>	_____
Vandalism .....	<input type="checkbox"/>	<input type="checkbox"/>	_____
<b>3. SITE CONDITIONS - Installation</b>			
Surface is Level - No Undulations .....	<input type="checkbox"/>	<input type="checkbox"/>	_____
Tiles and Joints are Straight .....	<input type="checkbox"/>	<input type="checkbox"/>	_____
Cuts Accurate and Tight			
A round Posts .....	<input type="checkbox"/>	<input type="checkbox"/>	_____
At Curbs .....	<input type="checkbox"/>	<input type="checkbox"/>	_____
<b>4. ADHESIVE</b>			
All Joints Adhered 100% - Level to Bevel .....	<input type="checkbox"/>	<input type="checkbox"/>	_____
All Edges and Cuts Adhered 100% .....	<input type="checkbox"/>	<input type="checkbox"/>	_____
Excessive Adhesive Removed .....	<input type="checkbox"/>	<input type="checkbox"/>	_____
<b>5. SECURE SURFACES</b>			
Edges Secure and Firm .....	<input type="checkbox"/>	<input type="checkbox"/>	_____
At Posts Secure and Firm .....	<input type="checkbox"/>	<input type="checkbox"/>	_____
Ramp Secure .....	<input type="checkbox"/>	<input type="checkbox"/>	_____

I hereby certify that the above areas are either in good working condition or deficiencies have been forwarded to the appropriate office.

Site Inspector: \_\_\_\_\_

Site Installer: \_\_\_\_\_

SEND COPY TO Rubber Designs @ 888-653-7529